

Power contactor, AC-3 400 A, 200 kW / 400 V AC (50-60 Hz) / DC operation 380-420 V UC Auxiliary contacts 2 NO + 2 NC 3-pole, Size S12 Busbar connections Drive: conventional Spring-type terminal



Figure similar

Product brand name	SIRIUS
Product designation	Power contactor
Product type designation	3RT1
General technical data	
Size of contactor	S12
Product extension	
• function module for communication	No
• Auxiliary switch	Yes
Surge voltage resistance	
• of main circuit rated value	8 kV
• of auxiliary circuit rated value	6 kV
maximum permissible voltage for safe isolation	
• between coil and main contacts acc. to EN 60947-1	690 V
Protection class IP	
• on the front	IP00; IP20 on the front with cover / box terminal
• of the terminal	IP00

Shock resistance at rectangular impulse	
<ul style="list-style-type: none"> • at AC • at DC 	8,5g / 5 ms, 4,2g / 10 ms 8,5g / 5 ms, 4,2g / 10 ms
Shock resistance with sine pulse	
<ul style="list-style-type: none"> • at AC • at DC 	13,4g / 5 ms, 6,5g / 10 ms 13,4g / 5 ms, 6,5g / 10 ms
Mechanical service life (switching cycles)	
<ul style="list-style-type: none"> • of contactor typical • of the contactor with added electronics-compatible auxiliary switch block typical • of the contactor with added auxiliary switch block typical 	10 000 000 5 000 000 10 000 000
Reference code acc. to DIN 40719 extended according to IEC 204-2 acc. to IEC 750	K
Reference code acc. to DIN EN 81346-2	Q

Ambient conditions

Installation altitude at height above sea level	
<ul style="list-style-type: none"> • maximum 	2 000 m
Ambient temperature	
<ul style="list-style-type: none"> • during operation • during storage 	-25 ... +60 °C -55 ... +80 °C

Main circuit

Number of poles for main current circuit	3
Number of NO contacts for main contacts	3
Operating voltage	
<ul style="list-style-type: none"> • at AC-3 rated value maximum 	1 000 V
Operating current	
<ul style="list-style-type: none"> • at AC-1 at 400 V <ul style="list-style-type: none"> — at ambient temperature 40 °C rated value • at AC-1 <ul style="list-style-type: none"> — up to 690 V at ambient temperature 40 °C rated value — up to 690 V at ambient temperature 60 °C rated value — up to 1000 V at ambient temperature 40 °C rated value — up to 1000 V at ambient temperature 60 °C rated value • at AC-2 at 400 V rated value • at AC-3 <ul style="list-style-type: none"> — at 400 V rated value — at 500 V rated value 	430 A 430 A 400 A 200 A 200 A 400 A 400 A 400 A

— at 690 V rated value	400 A
— at 1000 V rated value	180 A
• at AC-4 at 400 V rated value	350 A
Connectable conductor cross-section in main circuit at AC-1	
• at 60 °C minimum permissible	240 mm ²
• at 40 °C minimum permissible	300 mm ²
Operating current for approx. 200000 operating cycles at AC-4	
• at 400 V rated value	150 A
• at 690 V rated value	135 A
Operating current	
• at 1 current path at DC-1	
— at 24 V rated value	400 A
— at 110 V rated value	33 A
— at 220 V rated value	3.8 A
— at 440 V rated value	0.9 A
— at 600 V rated value	0.6 A
• with 2 current paths in series at DC-1	
— at 24 V rated value	400 A
— at 110 V rated value	400 A
— at 220 V rated value	400 A
— at 440 V rated value	4 A
— at 600 V rated value	2 A
• with 3 current paths in series at DC-1	
— at 24 V rated value	400 A
— at 110 V rated value	400 A
— at 220 V rated value	400 A
— at 440 V rated value	11 A
— at 600 V rated value	5.2 A
Operating current	
• at 1 current path at DC-3 at DC-5	
— at 24 V rated value	400 A
— at 110 V rated value	3 A
— at 220 V rated value	0.6 A
— at 440 V rated value	0.18 A
— at 600 V rated value	0.125 A
• with 2 current paths in series at DC-3 at DC-5	
— at 24 V rated value	400 A
— at 110 V rated value	400 A
— at 220 V rated value	2.5 A
— at 440 V rated value	0.65 A

<ul style="list-style-type: none"> — at 600 V rated value 	0.37 A
<ul style="list-style-type: none"> • with 3 current paths in series at DC-3 at DC-5 <ul style="list-style-type: none"> — at 24 V rated value — at 110 V rated value — at 220 V rated value — at 440 V rated value — at 600 V rated value 	400 A 400 A 400 A 1.4 A 0.75 A
Operating power	
<ul style="list-style-type: none"> • at AC-1 <ul style="list-style-type: none"> — at 230 V at 60 °C rated value — at 400 V rated value — at 400 V at 60 °C rated value — at 690 V rated value — at 690 V at 60 °C rated value — at 1000 V at 60 °C rated value • at AC-2 at 400 V rated value • at AC-3 <ul style="list-style-type: none"> — at 230 V rated value — at 400 V rated value — at 500 V rated value — at 690 V rated value — at 1000 V rated value 	151 kW 263 kW 263 kW 454 kW 454 kW 329 kW 200 kW 132 kW 200 kW 250 kW 400 kW 250 kW
Operating power for approx. 200000 operating cycles at AC-4	
<ul style="list-style-type: none"> • at 400 V rated value • at 690 V rated value 	85 kW 133 kW
Thermal short-time current limited to 10 s	3 200 A
Power loss [W] at AC-3 at 400 V for rated value of the operating current per conductor	35 W
No-load switching frequency	
<ul style="list-style-type: none"> • at AC • at DC 	2 000 1/h 2 000 1/h
Operating frequency	
<ul style="list-style-type: none"> • at AC-1 maximum • at AC-2 maximum • at AC-3 maximum • at AC-4 maximum 	700 1/h 200 1/h 500 1/h 130 1/h
Control circuit/ Control	
Type of voltage of the control supply voltage	AC/DC
Control supply voltage at AC	
<ul style="list-style-type: none"> • at 50 Hz rated value 	380 ... 420 V

<ul style="list-style-type: none"> • at 60 Hz rated value 	380 ... 420 V
Control supply voltage at DC	
<ul style="list-style-type: none"> • rated value 	380 ... 420 V
Operating range factor control supply voltage rated value of magnet coil at DC	
<ul style="list-style-type: none"> • initial value • Full-scale value 	0.8 1.1
Operating range factor control supply voltage rated value of magnet coil at AC	
<ul style="list-style-type: none"> • at 50 Hz • at 60 Hz 	0.8 ... 1.1 0.8 ... 1.1
Design of the surge suppressor	with varistor
Apparent pick-up power of magnet coil at AC	
<ul style="list-style-type: none"> • at 50 Hz 	830 V·A
Inductive power factor with closing power of the coil	
<ul style="list-style-type: none"> • at 50 Hz 	0.9
Apparent holding power of magnet coil at AC	
<ul style="list-style-type: none"> • at 50 Hz 	9.2 V·A
Inductive power factor with the holding power of the coil	
<ul style="list-style-type: none"> • at 50 Hz 	0.9
Closing power of magnet coil at DC	920 W
Holding power of magnet coil at DC	10 W
Closing delay	
<ul style="list-style-type: none"> • at AC • at DC 	45 ... 100 ms 45 ... 100 ms
Opening delay	
<ul style="list-style-type: none"> • at AC • at DC 	60 ... 100 ms 60 ... 100 ms
Arcing time	10 ... 15 ms
Control version of the switch operating mechanism	Standard A1 - A2
Auxiliary circuit	
Number of NC contacts for auxiliary contacts	
<ul style="list-style-type: none"> • instantaneous contact 	2
Number of NO contacts for auxiliary contacts	
<ul style="list-style-type: none"> • instantaneous contact 	2
Operating current at AC-12 maximum	10 A
Operating current at AC-15	
<ul style="list-style-type: none"> • at 230 V rated value • at 400 V rated value • at 500 V rated value • at 690 V rated value 	6 A 3 A 2 A 1 A

Operating current at DC-12	
<ul style="list-style-type: none"> • at 24 V rated value • at 48 V rated value • at 60 V rated value • at 110 V rated value • at 125 V rated value • at 220 V rated value • at 600 V rated value 	<p>10 A</p> <p>6 A</p> <p>6 A</p> <p>3 A</p> <p>2 A</p> <p>1 A</p> <p>0.15 A</p>
Operating current at DC-13	
<ul style="list-style-type: none"> • at 24 V rated value • at 48 V rated value • at 60 V rated value • at 110 V rated value • at 125 V rated value • at 220 V rated value • at 600 V rated value 	<p>10 A</p> <p>2 A</p> <p>2 A</p> <p>1 A</p> <p>0.9 A</p> <p>0.3 A</p> <p>0.1 A</p>
Contact reliability of auxiliary contacts	1 faulty switching per 100 million (17 V, 1 mA)

UL/CSA ratings

Full-load current (FLA) for three-phase AC motor	
<ul style="list-style-type: none"> • at 480 V rated value • at 600 V rated value 	<p>361 A</p> <p>382 A</p>
Yielded mechanical performance [hp]	
<ul style="list-style-type: none"> • for three-phase AC motor <ul style="list-style-type: none"> — at 200/208 V rated value — at 220/230 V rated value — at 460/480 V rated value — at 575/600 V rated value 	<p>125 hp</p> <p>150 hp</p> <p>300 hp</p> <p>400 hp</p>
Contact rating of auxiliary contacts according to UL	A600 / Q600

Short-circuit protection

Design of the fuse link	
<ul style="list-style-type: none"> • for short-circuit protection of the main circuit <ul style="list-style-type: none"> — with type of coordination 1 required — with type of assignment 2 required • for short-circuit protection of the auxiliary switch required 	<p>gG: 630 A (690 V, 100 kA)</p> <p>gG: 500 A (690 V, 100 kA), aM: 400 A (690 V, 50 kA), BS88: 450 A (415 V, 50 kA)</p> <p>gG: 10 A (500 V, 1 kA)</p>

Installation/ mounting/ dimensions

Mounting position	with vertical mounting surface +/-90° rotatable, with vertical mounting surface +/- 22.5° tiltable to the front and back
Mounting type	screw fixing
<ul style="list-style-type: none"> • Side-by-side mounting 	Yes

Height	214 mm
Width	160 mm
Depth	225 mm
Required spacing	
<ul style="list-style-type: none"> • with side-by-side mounting <ul style="list-style-type: none"> — forwards 20 mm — upwards 10 mm — downwards 10 mm — at the side 0 mm • for grounded parts <ul style="list-style-type: none"> — forwards 20 mm — upwards 10 mm — at the side 10 mm — downwards 10 mm • for live parts <ul style="list-style-type: none"> — forwards 20 mm — upwards 10 mm — downwards 10 mm — at the side 10 mm 	

Connections/Terminals





Type of electrical connection	
<ul style="list-style-type: none"> • for main current circuit • for auxiliary and control current circuit 	<p>Connection bar</p> <p>spring-loaded terminals</p>
Type of connectable conductor cross-sections	
<ul style="list-style-type: none"> • at AWG conductors for main contacts 	2/0 ... 500 kcmil
Connectable conductor cross-section for main contacts	
<ul style="list-style-type: none"> • stranded 	70 ... 240 mm ²
Connectable conductor cross-section for auxiliary contacts	
<ul style="list-style-type: none"> • single or multi-stranded • finely stranded with core end processing • finely stranded without core end processing 	<p>0.25 ... 2.5 mm²</p> <p>0.25 ... 1.5 mm²</p> <p>0.25 ... 2.5 mm²</p>
Type of connectable conductor cross-sections	
<ul style="list-style-type: none"> • for auxiliary contacts <ul style="list-style-type: none"> — solid — single or multi-stranded — finely stranded with core end processing — finely stranded without core end processing • at AWG conductors for auxiliary contacts 	<p>2x (0.25 ... 2.5 mm²)</p> <p>2x (0,25 ... 2,5 mm²)</p> <p>2x (0.25 ... 1.5 mm²)</p> <p>2x (0.25 ... 2.5 mm²)</p> <p>2x (24 ... 14)</p>



AWG number as coded connectable conductor cross section	
<ul style="list-style-type: none"> for auxiliary contacts 	24 ... 14

Safety related data

B10 value	
<ul style="list-style-type: none"> with high demand rate acc. to SN 31920 	1 000 000
Product function	
<ul style="list-style-type: none"> Mirror contact acc. to IEC 60947-4-1 positively driven operation acc. to IEC 60947-5-1 	Yes No
Protection against electrical shock	finger-safe when touched vertically from front acc. to IEC 60529

Certificates/approvals

General Product Approval	Functional Safety/Safety of Machinery	Declaration of Conformity	Test Certificates
 CSA	 UL	 EAC	 EG-Konf.
	Type Examination Certificate		Special Test Certificate

Test Certificates	Marine / Shipping	other
Type Test Certificates/Test Report	 ABS  RMRS	Confirmation Miscellaneous

Further information

- Information- and Downloadcenter (Catalogs, Brochures,...)**
<http://www.siemens.com/industrial-controls/catalogs>
- Industry Mall (Online ordering system)**
<https://mall.industry.siemens.com/mall/en/en/Catalog/product?mlfb=3RT1075-2AV36>
- Cax online generator**
<http://support.automation.siemens.com/WW/CAXorder/default.aspx?lang=en&mlfb=3RT1075-2AV36>
- Service&Support (Manuals, Certificates, Characteristics, FAQs,...)**
<https://support.industry.siemens.com/cs/ww/en/ps/3RT1075-2AV36>
- Image database (product images, 2D dimension drawings, 3D models, device circuit diagrams, EPLAN macros, ...)**
http://www.automation.siemens.com/bilddb/cax_de.aspx?mlfb=3RT1075-2AV36&lang=en
- Characteristic: Tripping characteristics, I²t, Let-through current**
<https://support.industry.siemens.com/cs/ww/en/ps/3RT1075-2AV36/char>
- Further characteristics (e.g. electrical endurance, switching frequency)**
<http://www.automation.siemens.com/bilddb/index.aspx?view=Search&mlfb=3RT1075-2AV36&objecttype=14&gridview=view1>

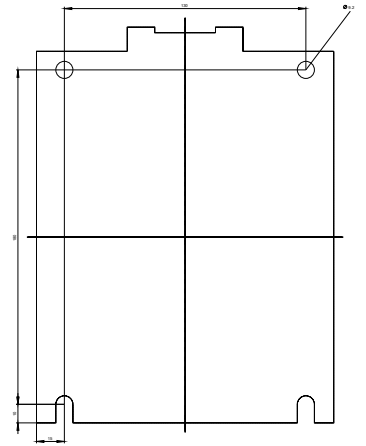
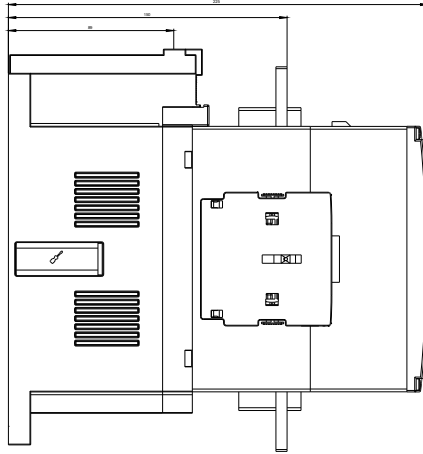
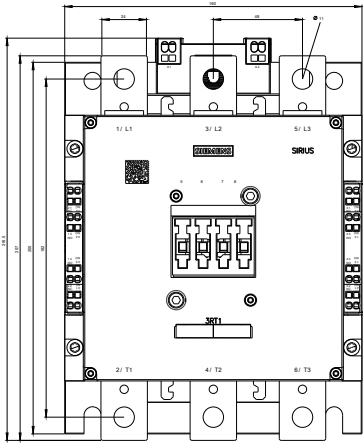



last modified:

12/22/2018