

Power contactor, AC-3 500 A, 250 kW / 400 V AC (50-60 Hz) / DC 500-550 V UC Auxiliary contacts 2 NO + 2 NC 3-pole, size S12 Busbar connections Operating mechanism: conventional screw terminals



Figure similar

<b>Product brand name</b>	SIRIUS
<b>Product designation</b>	Power contactor
<b>Product type designation</b>	3RT1
<b>General technical data</b>	
<b>Size of contactor</b>	S12
<b>Product extension</b>	
• function module for communication	No
• Auxiliary switch	Yes
<b>Surge voltage resistance</b>	
• of main circuit rated value	8 kV
• of auxiliary circuit rated value	6 kV
<b>maximum permissible voltage for safe isolation</b>	
• between coil and main contacts acc. to EN 60947-1	690 V
<b>Protection class IP</b>	
• on the front	IP00; IP20 on the front with cover / box terminal
• of the terminal	IP00

<b>Shock resistance at rectangular impulse</b>	
<ul style="list-style-type: none"> <li>• at AC</li> <li>• at DC</li> </ul>	8,5g / 5 ms, 4,2g / 10 ms 8,5g / 5 ms, 4,2g / 10 ms
<b>Shock resistance with sine pulse</b>	
<ul style="list-style-type: none"> <li>• at AC</li> <li>• at DC</li> </ul>	13,4g / 5 ms, 6,5g / 10 ms 13,4g / 5 ms, 6,5g / 10 ms
<b>Mechanical service life (switching cycles)</b>	
<ul style="list-style-type: none"> <li>• of contactor typical</li> <li>• of the contactor with added electronics-compatible auxiliary switch block typical</li> <li>• of the contactor with added auxiliary switch block typical</li> </ul>	10 000 000 5 000 000 10 000 000
<b>Reference code acc. to DIN 40719 extended according to IEC 204-2 acc. to IEC 750</b>	K
<b>Reference code acc. to DIN EN 81346-2</b>	Q

### Ambient conditions

<b>Installation altitude at height above sea level</b>	
<ul style="list-style-type: none"> <li>• maximum</li> </ul>	2 000 m
<b>Ambient temperature</b>	
<ul style="list-style-type: none"> <li>• during operation</li> <li>• during storage</li> </ul>	-25 ... +60 °C -55 ... +80 °C

### Main circuit

<b>Number of poles for main current circuit</b>	3
<b>Number of NO contacts for main contacts</b>	3
<b>Operating voltage</b>	
<ul style="list-style-type: none"> <li>• at AC-3 rated value maximum</li> </ul>	1 000 V
<b>Operating current</b>	
<ul style="list-style-type: none"> <li>• at AC-1 at 400 V <ul style="list-style-type: none"> <li>— at ambient temperature 40 °C rated value</li> </ul> </li> <li>• at AC-1 <ul style="list-style-type: none"> <li>— up to 690 V at ambient temperature 40 °C rated value</li> <li>— up to 690 V at ambient temperature 60 °C rated value</li> <li>— up to 1000 V at ambient temperature 40 °C rated value</li> <li>— up to 1000 V at ambient temperature 60 °C rated value</li> </ul> </li> <li>• at AC-2 at 400 V rated value</li> <li>• at AC-3 <ul style="list-style-type: none"> <li>— at 400 V rated value</li> <li>— at 500 V rated value</li> </ul> </li> </ul>	610 A 610 A 550 A 200 A 200 A 500 A 500 A 500 A

— at 690 V rated value	450 A
— at 1000 V rated value	180 A
• at AC-4 at 400 V rated value	430 A
<b>Connectable conductor cross-section in main circuit at AC-1</b>	
• at 60 °C minimum permissible	370 mm <sup>2</sup>
• at 40 °C minimum permissible	370 mm <sup>2</sup>
<b>Operating current for approx. 200000 operating cycles at AC-4</b>	
• at 400 V rated value	175 A
• at 690 V rated value	150 A
<b>Operating current</b>	
• at 1 current path at DC-1	
— at 24 V rated value	400 A
— at 110 V rated value	33 A
— at 220 V rated value	3.8 A
— at 440 V rated value	0.9 A
— at 600 V rated value	0.6 A
• with 2 current paths in series at DC-1	
— at 24 V rated value	400 A
— at 110 V rated value	400 A
— at 220 V rated value	400 A
— at 440 V rated value	4 A
— at 600 V rated value	2 A
• with 3 current paths in series at DC-1	
— at 24 V rated value	400 A
— at 110 V rated value	400 A
— at 220 V rated value	400 A
— at 440 V rated value	11 A
— at 600 V rated value	5.2 A
<b>Operating current</b>	
• at 1 current path at DC-3 at DC-5	
— at 24 V rated value	400 A
— at 110 V rated value	3 A
— at 220 V rated value	0.6 A
— at 440 V rated value	0.18 A
— at 600 V rated value	0.125 A
• with 2 current paths in series at DC-3 at DC-5	
— at 24 V rated value	400 A
— at 110 V rated value	400 A
— at 220 V rated value	2.5 A
— at 440 V rated value	0.65 A

<ul style="list-style-type: none"> <li>— at 600 V rated value</li> </ul>	0.37 A
<ul style="list-style-type: none"> <li>• with 3 current paths in series at DC-3 at DC-5 <ul style="list-style-type: none"> <li>— at 24 V rated value</li> <li>— at 110 V rated value</li> <li>— at 220 V rated value</li> <li>— at 440 V rated value</li> <li>— at 600 V rated value</li> </ul> </li> </ul>	400 A 400 A 400 A 1.4 A 0.75 A
<b>Operating power</b>	
<ul style="list-style-type: none"> <li>• at AC-1 <ul style="list-style-type: none"> <li>— at 230 V at 60 °C rated value</li> <li>— at 400 V rated value</li> <li>— at 400 V at 60 °C rated value</li> <li>— at 690 V rated value</li> <li>— at 690 V at 60 °C rated value</li> <li>— at 1000 V at 60 °C rated value</li> </ul> </li> <li>• at AC-2 at 400 V rated value</li> <li>• at AC-3 <ul style="list-style-type: none"> <li>— at 230 V rated value</li> <li>— at 400 V rated value</li> <li>— at 500 V rated value</li> <li>— at 690 V rated value</li> <li>— at 1000 V rated value</li> </ul> </li> </ul>	208 kW 362 kW 362 kW 624 kW 624 kW 329 kW 250 kW 160 kW 250 kW 315 kW 400 kW 250 kW
<b>Operating power for approx. 200000 operating cycles at AC-4</b>	
<ul style="list-style-type: none"> <li>• at 400 V rated value</li> <li>• at 690 V rated value</li> </ul>	98 kW 148 kW
<b>Thermal short-time current limited to 10 s</b>	4 000 A
<b>Power loss [W] at AC-3 at 400 V for rated value of the operating current per conductor</b>	55 W
<b>No-load switching frequency</b>	
<ul style="list-style-type: none"> <li>• at AC</li> <li>• at DC</li> </ul>	2 000 1/h 2 000 1/h
<b>Operating frequency</b>	
<ul style="list-style-type: none"> <li>• at AC-1 maximum</li> <li>• at AC-2 maximum</li> <li>• at AC-3 maximum</li> <li>• at AC-4 maximum</li> </ul>	500 1/h 170 1/h 420 1/h 130 1/h
<b>Control circuit/ Control</b>	
<b>Type of voltage of the control supply voltage</b>	AC/DC
<b>Control supply voltage at AC</b>	
<ul style="list-style-type: none"> <li>• at 50 Hz rated value</li> </ul>	500 ... 550 V

<ul style="list-style-type: none"> <li>• at 60 Hz rated value</li> </ul>	500 ... 550 V
<b>Control supply voltage at DC</b>	
<ul style="list-style-type: none"> <li>• rated value</li> </ul>	500 ... 550 V
<b>Operating range factor control supply voltage rated value of magnet coil at DC</b>	
<ul style="list-style-type: none"> <li>• initial value</li> </ul>	0.8
<ul style="list-style-type: none"> <li>• Full-scale value</li> </ul>	1.1
<b>Operating range factor control supply voltage rated value of magnet coil at AC</b>	
<ul style="list-style-type: none"> <li>• at 50 Hz</li> </ul>	0.8 ... 1.1
<ul style="list-style-type: none"> <li>• at 60 Hz</li> </ul>	0.8 ... 1.1
<b>Design of the surge suppressor</b>	with varistor
<b>Apparent pick-up power of magnet coil at AC</b>	
<ul style="list-style-type: none"> <li>• at 50 Hz</li> </ul>	830 V·A
<b>Inductive power factor with closing power of the coil</b>	
<ul style="list-style-type: none"> <li>• at 50 Hz</li> </ul>	0.9
<b>Apparent holding power of magnet coil at AC</b>	
<ul style="list-style-type: none"> <li>• at 50 Hz</li> </ul>	9.2 V·A
<b>Inductive power factor with the holding power of the coil</b>	
<ul style="list-style-type: none"> <li>• at 50 Hz</li> </ul>	0.9
<b>Closing power of magnet coil at DC</b>	920 W
<b>Holding power of magnet coil at DC</b>	10 W
<b>Closing delay</b>	
<ul style="list-style-type: none"> <li>• at AC</li> </ul>	45 ... 100 ms
<ul style="list-style-type: none"> <li>• at DC</li> </ul>	45 ... 100 ms
<b>Opening delay</b>	
<ul style="list-style-type: none"> <li>• at AC</li> </ul>	60 ... 100 ms
<ul style="list-style-type: none"> <li>• at DC</li> </ul>	60 ... 100 ms
<b>Arcing time</b>	10 ... 15 ms
<b>Control version of the switch operating mechanism</b>	Standard A1 - A2
<b>Auxiliary circuit</b>	
<b>Number of NC contacts for auxiliary contacts</b>	
<ul style="list-style-type: none"> <li>• instantaneous contact</li> </ul>	2
<b>Number of NO contacts for auxiliary contacts</b>	
<ul style="list-style-type: none"> <li>• instantaneous contact</li> </ul>	2
<b>Operating current at AC-12 maximum</b>	10 A
<b>Operating current at AC-15</b>	
<ul style="list-style-type: none"> <li>• at 230 V rated value</li> </ul>	6 A
<ul style="list-style-type: none"> <li>• at 400 V rated value</li> </ul>	3 A
<ul style="list-style-type: none"> <li>• at 500 V rated value</li> </ul>	2 A
<ul style="list-style-type: none"> <li>• at 690 V rated value</li> </ul>	1 A

<b>Operating current at DC-12</b>	
<ul style="list-style-type: none"> <li>• at 24 V rated value</li> <li>• at 48 V rated value</li> <li>• at 60 V rated value</li> <li>• at 110 V rated value</li> <li>• at 125 V rated value</li> <li>• at 220 V rated value</li> <li>• at 600 V rated value</li> </ul>	<p>10 A</p> <p>6 A</p> <p>6 A</p> <p>3 A</p> <p>2 A</p> <p>1 A</p> <p>0.15 A</p>
<b>Operating current at DC-13</b>	
<ul style="list-style-type: none"> <li>• at 24 V rated value</li> <li>• at 48 V rated value</li> <li>• at 60 V rated value</li> <li>• at 110 V rated value</li> <li>• at 125 V rated value</li> <li>• at 220 V rated value</li> <li>• at 600 V rated value</li> </ul>	<p>10 A</p> <p>2 A</p> <p>2 A</p> <p>1 A</p> <p>0.9 A</p> <p>0.3 A</p> <p>0.1 A</p>
<b>Contact reliability of auxiliary contacts</b>	1 faulty switching per 100 million (17 V, 1 mA)

#### UL/CSA ratings

<b>Full-load current (FLA) for three-phase AC motor</b>	
<ul style="list-style-type: none"> <li>• at 480 V rated value</li> <li>• at 600 V rated value</li> </ul>	<p>477 A</p> <p>472 A</p>
<b>Yielded mechanical performance [hp]</b>	
<ul style="list-style-type: none"> <li>• for three-phase AC motor <ul style="list-style-type: none"> <li>— at 200/208 V rated value</li> <li>— at 220/230 V rated value</li> <li>— at 460/480 V rated value</li> <li>— at 575/600 V rated value</li> </ul> </li> </ul>	<p>150 hp</p> <p>200 hp</p> <p>400 hp</p> <p>500 hp</p>
<b>Contact rating of auxiliary contacts according to UL</b>	A600 / Q600

#### Short-circuit protection

<b>Design of the fuse link</b>	
<ul style="list-style-type: none"> <li>• for short-circuit protection of the main circuit <ul style="list-style-type: none"> <li>— with type of coordination 1 required</li> <li>— with type of assignment 2 required</li> </ul> </li> <li>• for short-circuit protection of the auxiliary switch required</li> </ul>	<p>gG: 630 A (690 V, 100 kA)</p> <p>gG: 500 A (690 V, 100 kA), aM: 500 A (690 V, 50 kA), BS88: 500 A (415 V, 50 kA)</p> <p>gG: 10 A (500 V, 1 kA)</p>

#### Installation/ mounting/ dimensions

<b>Mounting position</b>	with vertical mounting surface +/-90° rotatable, with vertical mounting surface +/- 22.5° tiltable to the front and back
<b>Mounting type</b>	screw fixing
<ul style="list-style-type: none"> <li>• Side-by-side mounting</li> </ul>	Yes

<b>Height</b>	214 mm
<b>Width</b>	160 mm
<b>Depth</b>	225 mm
<b>Required spacing</b>	
<ul style="list-style-type: none"> <li>• with side-by-side mounting <ul style="list-style-type: none"> <li>— forwards 20 mm</li> <li>— upwards 10 mm</li> <li>— downwards 10 mm</li> <li>— at the side 0 mm</li> </ul> </li> <li>• for grounded parts <ul style="list-style-type: none"> <li>— forwards 20 mm</li> <li>— upwards 10 mm</li> <li>— at the side 10 mm</li> <li>— downwards 10 mm</li> </ul> </li> <li>• for live parts <ul style="list-style-type: none"> <li>— forwards 20 mm</li> <li>— upwards 10 mm</li> <li>— downwards 10 mm</li> <li>— at the side 10 mm</li> </ul> </li> </ul>	





## Connections/Terminals



<b>Type of electrical connection</b>	
<ul style="list-style-type: none"> <li>• for main current circuit</li> <li>• for auxiliary and control current circuit</li> </ul>	Connection bar screw-type terminals
<b>Type of connectable conductor cross-sections</b>	
<ul style="list-style-type: none"> <li>• at AWG conductors for main contacts</li> </ul>	2/0 ... 500 kcmil
<b>Connectable conductor cross-section for main contacts</b>	
<ul style="list-style-type: none"> <li>• stranded</li> </ul>	70 ... 240 mm <sup>2</sup>
<b>Connectable conductor cross-section for auxiliary contacts</b>	
<ul style="list-style-type: none"> <li>• single or multi-stranded</li> <li>• finely stranded with core end processing</li> </ul>	0.5 ... 4 mm <sup>2</sup> 0.5 ... 2.5 mm <sup>2</sup>
<b>Type of connectable conductor cross-sections</b>	
<ul style="list-style-type: none"> <li>• for auxiliary contacts <ul style="list-style-type: none"> <li>— solid 2x (0.5 ... 1.5 mm<sup>2</sup>), 2x (0.75 ... 2.5 mm<sup>2</sup>), max. 2x (0.75 ... 4 mm<sup>2</sup>)</li> <li>— single or multi-stranded 2x (0,5 ... 1,5 mm<sup>2</sup>), 2x (0,75 ... 2,5 mm<sup>2</sup>), max. 2x (0,75 ... 4 mm<sup>2</sup>)</li> <li>— finely stranded with core end processing 2x (0.5 ... 1.5 mm<sup>2</sup>), 2x (0.75 ... 2.5 mm<sup>2</sup>)</li> </ul> </li> <li>• at AWG conductors for auxiliary contacts 2x (20 ... 16), 2x (18 ... 14), 1x 12</li> </ul>	
<b>AWG number as coded connectable conductor cross section</b>	
<ul style="list-style-type: none"> <li>• for auxiliary contacts</li> </ul>	18 ... 14

## Safety related data

<b>B10 value</b>	
<ul style="list-style-type: none"> <li>with high demand rate acc. to SN 31920</li> </ul>	1 000 000
<b>Product function</b>	
<ul style="list-style-type: none"> <li>Mirror contact acc. to IEC 60947-4-1</li> <li>positively driven operation acc. to IEC 60947-5-1</li> </ul>	<p>Yes</p> <p>No</p>
<b>Protection against electrical shock</b>	finger-safe when touched vertically from front acc. to IEC 60529

## Certificates/approvals

General Product Approval	Functional Safety/Safety of Machinery	Declaration of Conformity	Test Certificates
 CSA  UL  EAC	<a href="#">Type Examination Certificate</a>	 EG-Konf.	<a href="#">Special Test Certificate</a>

Test Certificates	Marine / Shipping	other
<a href="#">Type Test Certificates/Test Report</a>	 ABS  RMRS  DNV-GL <small>DNVGL.COM/AF</small>	<a href="#">Confirmation</a> <a href="#">Miscellaneous</a>

## Further information

### Information- and Downloadcenter (Catalogs, Brochures,...)

<http://www.siemens.com/industrial-controls/catalogs>

### Industry Mall (Online ordering system)

<https://mall.industry.siemens.com/mall/en/en/Catalog/product?mlfb=3RT1076-6AS36>

### Cax online generator

<http://support.automation.siemens.com/WW/CAXorder/default.aspx?lang=en&mlfb=3RT1076-6AS36>

### Service&Support (Manuals, Certificates, Characteristics, FAQs,...)

<https://support.industry.siemens.com/cs/ww/en/ps/3RT1076-6AS36>

### Image database (product images, 2D dimension drawings, 3D models, device circuit diagrams, EPLAN macros, ...)

[http://www.automation.siemens.com/bilddb/cax\\_de.aspx?mlfb=3RT1076-6AS36&lang=en](http://www.automation.siemens.com/bilddb/cax_de.aspx?mlfb=3RT1076-6AS36&lang=en)

### Characteristic: Tripping characteristics, I<sup>t</sup>, Let-through current

<https://support.industry.siemens.com/cs/ww/en/ps/3RT1076-6AS36/char>

### Further characteristics (e.g. electrical endurance, switching frequency)

<http://www.automation.siemens.com/bilddb/index.aspx?view=Search&mlfb=3RT1076-6AS36&objecttype=14&gridview=view1>



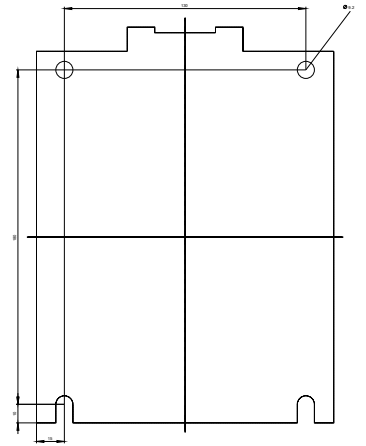
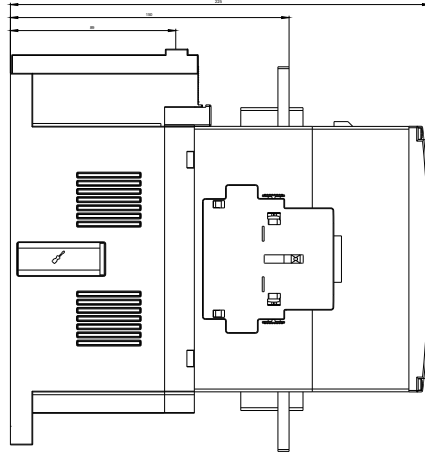
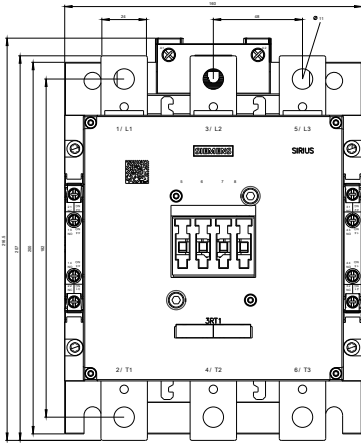

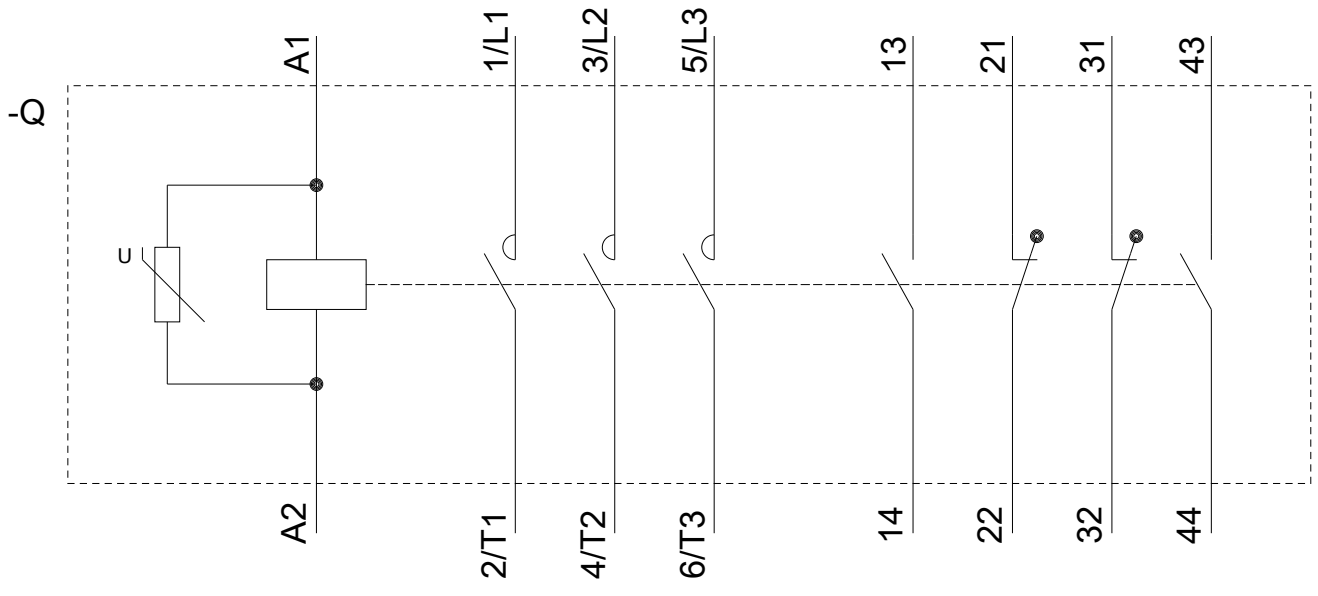

last modified:

12/22/2018