

Power contactor, AC-3 500 A, 250 kW / 400 V AC (50-60 Hz) / DC
 380-420 V UC Auxiliary contacts 2 NO + 2 NC 3-pole, size S12
 Busbar connections Operating mechanism: conventional screw
 terminals



Figure similar

Product brand name	SIRIUS
Product designation	Power contactor
Product type designation	3RT1

General technical data	
Size of contactor	S12
Product extension	
<ul style="list-style-type: none"> function module for communication 	No
<ul style="list-style-type: none"> Auxiliary switch 	Yes
Surge voltage resistance	
<ul style="list-style-type: none"> of main circuit rated value 	8 kV
<ul style="list-style-type: none"> of auxiliary circuit rated value 	6 kV
maximum permissible voltage for safe isolation	
<ul style="list-style-type: none"> between coil and main contacts acc. to EN 60947-1 	690 V
Protection class IP	
<ul style="list-style-type: none"> on the front 	IP00; IP20 on the front with cover / box terminal
<ul style="list-style-type: none"> of the terminal 	IP00

Shock resistance at rectangular impulse	
<ul style="list-style-type: none"> • at AC • at DC 	8,5g / 5 ms, 4,2g / 10 ms 8,5g / 5 ms, 4,2g / 10 ms
Shock resistance with sine pulse	
<ul style="list-style-type: none"> • at AC • at DC 	13,4g / 5 ms, 6,5g / 10 ms 13,4g / 5 ms, 6,5g / 10 ms
Mechanical service life (switching cycles)	
<ul style="list-style-type: none"> • of contactor typical • of the contactor with added electronics-compatible auxiliary switch block typical • of the contactor with added auxiliary switch block typical 	10 000 000 5 000 000 10 000 000
Reference code acc. to DIN 40719 extended according to IEC 204-2 acc. to IEC 750	K
Reference code acc. to DIN EN 81346-2	Q

Ambient conditions

Installation altitude at height above sea level	
<ul style="list-style-type: none"> • maximum 	2 000 m
Ambient temperature	
<ul style="list-style-type: none"> • during operation • during storage 	-25 ... +60 °C -55 ... +80 °C

Main circuit

Number of poles for main current circuit	3
Number of NO contacts for main contacts	3
Operating voltage	
<ul style="list-style-type: none"> • at AC-3 rated value maximum 	1 000 V
Operating current	
<ul style="list-style-type: none"> • at AC-1 at 400 V <ul style="list-style-type: none"> — at ambient temperature 40 °C rated value • at AC-1 <ul style="list-style-type: none"> — up to 690 V at ambient temperature 40 °C rated value — up to 690 V at ambient temperature 60 °C rated value — up to 1000 V at ambient temperature 40 °C rated value — up to 1000 V at ambient temperature 60 °C rated value • at AC-2 at 400 V rated value • at AC-3 <ul style="list-style-type: none"> — at 400 V rated value — at 500 V rated value 	610 A 610 A 550 A 200 A 200 A 500 A 500 A 500 A

— at 690 V rated value	450 A
— at 1000 V rated value	180 A
• at AC-4 at 400 V rated value	430 A
Connectable conductor cross-section in main circuit at AC-1	
• at 60 °C minimum permissible	370 mm ²
• at 40 °C minimum permissible	370 mm ²
Operating current for approx. 200000 operating cycles at AC-4	
• at 400 V rated value	175 A
• at 690 V rated value	150 A
Operating current	
• at 1 current path at DC-1	
— at 24 V rated value	400 A
— at 110 V rated value	33 A
— at 220 V rated value	3.8 A
— at 440 V rated value	0.9 A
— at 600 V rated value	0.6 A
• with 2 current paths in series at DC-1	
— at 24 V rated value	400 A
— at 110 V rated value	400 A
— at 220 V rated value	400 A
— at 440 V rated value	4 A
— at 600 V rated value	2 A
• with 3 current paths in series at DC-1	
— at 24 V rated value	400 A
— at 110 V rated value	400 A
— at 220 V rated value	400 A
— at 440 V rated value	11 A
— at 600 V rated value	5.2 A
Operating current	
• at 1 current path at DC-3 at DC-5	
— at 24 V rated value	400 A
— at 110 V rated value	3 A
— at 220 V rated value	0.6 A
— at 440 V rated value	0.18 A
— at 600 V rated value	0.125 A
• with 2 current paths in series at DC-3 at DC-5	
— at 24 V rated value	400 A
— at 110 V rated value	400 A
— at 220 V rated value	2.5 A
— at 440 V rated value	0.65 A

<ul style="list-style-type: none"> — at 600 V rated value 	0.37 A
<ul style="list-style-type: none"> • with 3 current paths in series at DC-3 at DC-5 <ul style="list-style-type: none"> — at 24 V rated value — at 110 V rated value — at 220 V rated value — at 440 V rated value — at 600 V rated value 	400 A 400 A 400 A 1.4 A 0.75 A
Operating power	
<ul style="list-style-type: none"> • at AC-1 <ul style="list-style-type: none"> — at 230 V at 60 °C rated value — at 400 V rated value — at 400 V at 60 °C rated value — at 690 V rated value — at 690 V at 60 °C rated value — at 1000 V at 60 °C rated value • at AC-2 at 400 V rated value • at AC-3 <ul style="list-style-type: none"> — at 230 V rated value — at 400 V rated value — at 500 V rated value — at 690 V rated value — at 1000 V rated value 	208 kW 362 kW 362 kW 624 kW 624 kW 329 kW 250 kW 160 kW 250 kW 315 kW 400 kW 250 kW
Operating power for approx. 200000 operating cycles at AC-4	
<ul style="list-style-type: none"> • at 400 V rated value • at 690 V rated value 	98 kW 148 kW
Thermal short-time current limited to 10 s	4 000 A
Power loss [W] at AC-3 at 400 V for rated value of the operating current per conductor	55 W
No-load switching frequency	
<ul style="list-style-type: none"> • at AC • at DC 	2 000 1/h 2 000 1/h
Operating frequency	
<ul style="list-style-type: none"> • at AC-1 maximum • at AC-2 maximum • at AC-3 maximum • at AC-4 maximum 	500 1/h 170 1/h 420 1/h 130 1/h
Control circuit/ Control	
Type of voltage of the control supply voltage	AC/DC
Control supply voltage at AC	
<ul style="list-style-type: none"> • at 50 Hz rated value 	380 ... 420 V

<ul style="list-style-type: none"> • at 60 Hz rated value 	380 ... 420 V
Control supply voltage at DC	
<ul style="list-style-type: none"> • rated value 	380 ... 420 V
Operating range factor control supply voltage rated value of magnet coil at DC	
<ul style="list-style-type: none"> • initial value 	0.8
<ul style="list-style-type: none"> • Full-scale value 	1.1
Operating range factor control supply voltage rated value of magnet coil at AC	
<ul style="list-style-type: none"> • at 50 Hz 	0.8 ... 1.1
<ul style="list-style-type: none"> • at 60 Hz 	0.8 ... 1.1
Design of the surge suppressor	with varistor
Apparent pick-up power of magnet coil at AC	
<ul style="list-style-type: none"> • at 50 Hz 	830 V·A
Inductive power factor with closing power of the coil	
<ul style="list-style-type: none"> • at 50 Hz 	0.9
Apparent holding power of magnet coil at AC	
<ul style="list-style-type: none"> • at 50 Hz 	9.2 V·A
Inductive power factor with the holding power of the coil	
<ul style="list-style-type: none"> • at 50 Hz 	0.9
Closing power of magnet coil at DC	920 W
Holding power of magnet coil at DC	10 W
Closing delay	
<ul style="list-style-type: none"> • at AC 	45 ... 100 ms
<ul style="list-style-type: none"> • at DC 	45 ... 100 ms
Opening delay	
<ul style="list-style-type: none"> • at AC 	60 ... 100 ms
<ul style="list-style-type: none"> • at DC 	60 ... 100 ms
Arcing time	10 ... 15 ms
Control version of the switch operating mechanism	Standard A1 - A2
Auxiliary circuit	
Number of NC contacts for auxiliary contacts	
<ul style="list-style-type: none"> • instantaneous contact 	2
Number of NO contacts for auxiliary contacts	
<ul style="list-style-type: none"> • instantaneous contact 	2
Operating current at AC-12 maximum	10 A
Operating current at AC-15	
<ul style="list-style-type: none"> • at 230 V rated value 	6 A
<ul style="list-style-type: none"> • at 400 V rated value 	3 A
<ul style="list-style-type: none"> • at 500 V rated value 	2 A
<ul style="list-style-type: none"> • at 690 V rated value 	1 A

Operating current at DC-12	
<ul style="list-style-type: none"> • at 24 V rated value • at 48 V rated value • at 60 V rated value • at 110 V rated value • at 125 V rated value • at 220 V rated value • at 600 V rated value 	<p>10 A</p> <p>6 A</p> <p>6 A</p> <p>3 A</p> <p>2 A</p> <p>1 A</p> <p>0.15 A</p>
Operating current at DC-13	
<ul style="list-style-type: none"> • at 24 V rated value • at 48 V rated value • at 60 V rated value • at 110 V rated value • at 125 V rated value • at 220 V rated value • at 600 V rated value 	<p>10 A</p> <p>2 A</p> <p>2 A</p> <p>1 A</p> <p>0.9 A</p> <p>0.3 A</p> <p>0.1 A</p>
Contact reliability of auxiliary contacts	1 faulty switching per 100 million (17 V, 1 mA)

UL/CSA ratings

Full-load current (FLA) for three-phase AC motor	
<ul style="list-style-type: none"> • at 480 V rated value • at 600 V rated value 	<p>477 A</p> <p>472 A</p>
Yielded mechanical performance [hp]	
<ul style="list-style-type: none"> • for three-phase AC motor <ul style="list-style-type: none"> — at 200/208 V rated value — at 220/230 V rated value — at 460/480 V rated value — at 575/600 V rated value 	<p>150 hp</p> <p>200 hp</p> <p>400 hp</p> <p>500 hp</p>
Contact rating of auxiliary contacts according to UL	A600 / Q600

Short-circuit protection

Design of the fuse link	
<ul style="list-style-type: none"> • for short-circuit protection of the main circuit <ul style="list-style-type: none"> — with type of coordination 1 required — with type of assignment 2 required • for short-circuit protection of the auxiliary switch required 	<p>gG: 630 A (690 V, 100 kA)</p> <p>gG: 500 A (690 V, 100 kA), aM: 500 A (690 V, 50 kA), BS88: 500 A (415 V, 50 kA)</p> <p>gG: 10 A (500 V, 1 kA)</p>

Installation/ mounting/ dimensions

Mounting position	with vertical mounting surface +/-90° rotatable, with vertical mounting surface +/- 22.5° tiltable to the front and back
Mounting type	screw fixing
<ul style="list-style-type: none"> • Side-by-side mounting 	Yes

Height	214 mm
Width	160 mm
Depth	225 mm
Required spacing	
<ul style="list-style-type: none"> • with side-by-side mounting <ul style="list-style-type: none"> — forwards 20 mm — upwards 10 mm — downwards 10 mm — at the side 0 mm • for grounded parts <ul style="list-style-type: none"> — forwards 20 mm — upwards 10 mm — at the side 10 mm — downwards 10 mm • for live parts <ul style="list-style-type: none"> — forwards 20 mm — upwards 10 mm — downwards 10 mm — at the side 10 mm 	





Connections/Terminals



Type of electrical connection	
<ul style="list-style-type: none"> • for main current circuit • for auxiliary and control current circuit 	Connection bar screw-type terminals
Type of connectable conductor cross-sections	
<ul style="list-style-type: none"> • at AWG conductors for main contacts 	2/0 ... 500 kcmil
Connectable conductor cross-section for main contacts	
<ul style="list-style-type: none"> • stranded 	70 ... 240 mm ²
Connectable conductor cross-section for auxiliary contacts	
<ul style="list-style-type: none"> • single or multi-stranded • finely stranded with core end processing 	0.5 ... 4 mm ² 0.5 ... 2.5 mm ²
Type of connectable conductor cross-sections	
<ul style="list-style-type: none"> • for auxiliary contacts <ul style="list-style-type: none"> — solid 2x (0.5 ... 1.5 mm²), 2x (0.75 ... 2.5 mm²), max. 2x (0.75 ... 4 mm²) — single or multi-stranded 2x (0,5 ... 1,5 mm²), 2x (0,75 ... 2,5 mm²), max. 2x (0,75 ... 4 mm²) — finely stranded with core end processing 2x (0.5 ... 1.5 mm²), 2x (0.75 ... 2.5 mm²) • at AWG conductors for auxiliary contacts 2x (20 ... 16), 2x (18 ... 14), 1x 12 	
AWG number as coded connectable conductor cross section	
<ul style="list-style-type: none"> • for auxiliary contacts 	18 ... 14

Safety related data

B10 value	
<ul style="list-style-type: none"> with high demand rate acc. to SN 31920 	1 000 000
Product function	
<ul style="list-style-type: none"> Mirror contact acc. to IEC 60947-4-1 positively driven operation acc. to IEC 60947-5-1 	<p>Yes</p> <p>No</p>
Protection against electrical shock	finger-safe when touched vertically from front acc. to IEC 60529

Certificates/approvals

General Product Approval	Functional Safety/Safety of Machinery	Declaration of Conformity	Test Certificates
 CSA	 UL	 EAC	<p>Type Examination Certificate</p>  EG-Konf.
			<p>Special Test Certificate</p>

Test Certificates	Marine / Shipping	other
<p>Type Test Certificates/Test Report</p>	 ABS	 RMRS
	 DNV-GL DNVGL.COM/AF	<p>Miscellaneous</p> <p>Confirmation</p>

Further information

Information- and Downloadcenter (Catalogs, Brochures,...)

<http://www.siemens.com/industrial-controls/catalogs>

Industry Mall (Online ordering system)

<https://mall.industry.siemens.com/mall/en/en/Catalog/product?mlfb=3RT1076-6AV36>

Cax online generator

<http://support.automation.siemens.com/WW/CAXorder/default.aspx?lang=en&mlfb=3RT1076-6AV36>

Service&Support (Manuals, Certificates, Characteristics, FAQs,...)

<https://support.industry.siemens.com/cs/ww/en/ps/3RT1076-6AV36>

Image database (product images, 2D dimension drawings, 3D models, device circuit diagrams, EPLAN macros, ...)

http://www.automation.siemens.com/bilddb/cax_de.aspx?mlfb=3RT1076-6AV36&lang=en

Characteristic: Tripping characteristics, I^t, Let-through current

<https://support.industry.siemens.com/cs/ww/en/ps/3RT1076-6AV36/char>

Further characteristics (e.g. electrical endurance, switching frequency)

<http://www.automation.siemens.com/bilddb/index.aspx?view=Search&mlfb=3RT1076-6AV36&objecttype=14&gridview=view1>

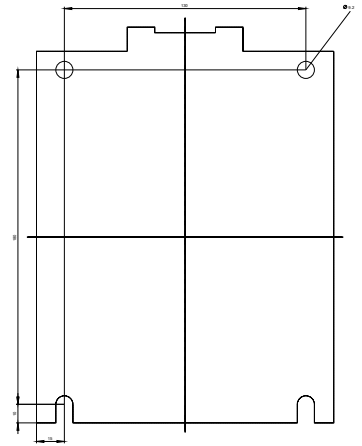
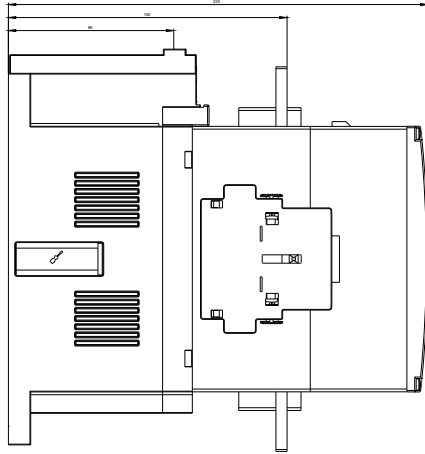
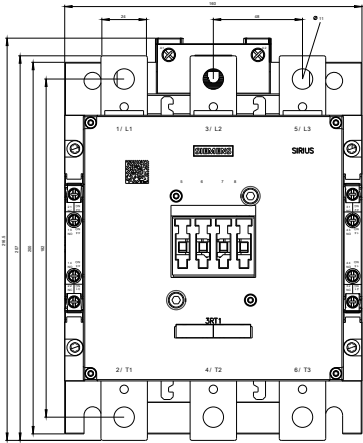



last modified:

12/22/2018