

Power contactor, AC-3 500 A, 250 kW / 400 V AC (50-60 Hz) / DC 96-127 V UC Auxiliary contacts 2 NO + 2 NC 3-pole, size S12 Busbar connections Operating mechanism: solid-state with PLC interface 24 V DC screw terminals



Figure similar

Product brand name	SIRIUS
Product designation	Power contactor
Product type designation	3RT1

General technical data	
Size of contactor	S12
Product extension	
<ul style="list-style-type: none"> function module for communication 	No
<ul style="list-style-type: none"> Auxiliary switch 	Yes
Surge voltage resistance	
<ul style="list-style-type: none"> of main circuit rated value 	8 kV
<ul style="list-style-type: none"> of auxiliary circuit rated value 	6 kV
maximum permissible voltage for safe isolation	
<ul style="list-style-type: none"> between coil and main contacts acc. to EN 60947-1 	690 V
Protection class IP	
<ul style="list-style-type: none"> on the front 	IP00; IP20 on the front with cover / box terminal
<ul style="list-style-type: none"> of the terminal 	IP00

Shock resistance at rectangular impulse	
<ul style="list-style-type: none"> • at AC • at DC 	8,5g / 5 ms, 4,2g / 10 ms 8,5g / 5 ms, 4,2g / 10 ms
Shock resistance with sine pulse	
<ul style="list-style-type: none"> • at AC • at DC 	13,4g / 5 ms, 6,5g / 10 ms 13,4g / 5 ms, 6,5g / 10 ms
Mechanical service life (switching cycles)	
<ul style="list-style-type: none"> • of contactor typical • of the contactor with added electronics-compatible auxiliary switch block typical • of the contactor with added auxiliary switch block typical 	10 000 000 5 000 000 10 000 000
Reference code acc. to DIN 40719 extended according to IEC 204-2 acc. to IEC 750	K
Reference code acc. to DIN EN 81346-2	Q

Ambient conditions

Installation altitude at height above sea level	
<ul style="list-style-type: none"> • maximum 	2 000 m
Ambient temperature	
<ul style="list-style-type: none"> • during operation • during storage 	-25 ... +60 °C -55 ... +80 °C

Main circuit

Number of poles for main current circuit	3
Number of NO contacts for main contacts	3
Operating voltage	
<ul style="list-style-type: none"> • at AC-3 rated value maximum 	1 000 V
Operating current	
<ul style="list-style-type: none"> • at AC-1 at 400 V <ul style="list-style-type: none"> — at ambient temperature 40 °C rated value • at AC-1 <ul style="list-style-type: none"> — up to 690 V at ambient temperature 40 °C rated value — up to 690 V at ambient temperature 60 °C rated value — up to 1000 V at ambient temperature 40 °C rated value — up to 1000 V at ambient temperature 60 °C rated value • at AC-2 at 400 V rated value • at AC-3 <ul style="list-style-type: none"> — at 400 V rated value — at 500 V rated value 	610 A 610 A 550 A 200 A 200 A 500 A 500 A 500 A

— at 690 V rated value	450 A
— at 1000 V rated value	180 A
• at AC-4 at 400 V rated value	430 A
Connectable conductor cross-section in main circuit at AC-1	
• at 60 °C minimum permissible	370 mm ²
• at 40 °C minimum permissible	370 mm ²
Operating current for approx. 200000 operating cycles at AC-4	
• at 400 V rated value	175 A
• at 690 V rated value	150 A
Operating current	
• at 1 current path at DC-1	
— at 24 V rated value	400 A
— at 110 V rated value	33 A
— at 220 V rated value	3.8 A
— at 440 V rated value	0.9 A
— at 600 V rated value	0.6 A
• with 2 current paths in series at DC-1	
— at 24 V rated value	400 A
— at 110 V rated value	400 A
— at 220 V rated value	400 A
— at 440 V rated value	4 A
— at 600 V rated value	2 A
• with 3 current paths in series at DC-1	
— at 24 V rated value	400 A
— at 110 V rated value	400 A
— at 220 V rated value	400 A
— at 440 V rated value	11 A
— at 600 V rated value	5.2 A
Operating current	
• at 1 current path at DC-3 at DC-5	
— at 24 V rated value	400 A
— at 110 V rated value	3 A
— at 220 V rated value	0.6 A
— at 440 V rated value	0.18 A
— at 600 V rated value	0.125 A
• with 2 current paths in series at DC-3 at DC-5	
— at 24 V rated value	400 A
— at 110 V rated value	400 A
— at 220 V rated value	2.5 A
— at 440 V rated value	0.65 A

— at 600 V rated value	0.37 A
• with 3 current paths in series at DC-3 at DC-5	
— at 24 V rated value	400 A
— at 110 V rated value	400 A
— at 220 V rated value	400 A
— at 440 V rated value	1.4 A
— at 600 V rated value	0.75 A
Operating power	
• at AC-1	
— at 230 V at 60 °C rated value	208 kW
— at 400 V rated value	362 kW
— at 400 V at 60 °C rated value	362 kW
— at 690 V rated value	624 kW
— at 690 V at 60 °C rated value	624 kW
— at 1000 V at 60 °C rated value	329 kW
• at AC-2 at 400 V rated value	250 kW
• at AC-3	
— at 230 V rated value	160 kW
— at 400 V rated value	250 kW
— at 500 V rated value	315 kW
— at 690 V rated value	400 kW
— at 1000 V rated value	250 kW
Operating power for approx. 200000 operating cycles at AC-4	
• at 400 V rated value	98 kW
• at 690 V rated value	148 kW
Thermal short-time current limited to 10 s	4 000 A
Power loss [W] at AC-3 at 400 V for rated value of the operating current per conductor	55 W
No-load switching frequency	
• at AC	1 000 1/h
• at DC	1 000 1/h
Operating frequency	
• at AC-1 maximum	500 1/h
• at AC-2 maximum	170 1/h
• at AC-3 maximum	420 1/h
• at AC-4 maximum	130 1/h
Control circuit/ Control	
Type of voltage of the control supply voltage	AC/DC
Control supply voltage at AC	
• at 50 Hz rated value	96 ... 127 V

<ul style="list-style-type: none"> • at 60 Hz rated value 	96 ... 127 V
Control supply voltage at DC	
<ul style="list-style-type: none"> • rated value 	96 ... 127 V
Type of PLC-control input acc. to IEC 60947-1	Type 1
Consumed current at PLC-control input acc. to IEC 60947-1 maximum	20 mA
Operating range factor control supply voltage rated value of magnet coil at DC	
<ul style="list-style-type: none"> • initial value 	0.8
<ul style="list-style-type: none"> • Full-scale value 	1.1
Operating range factor control supply voltage rated value of magnet coil at AC	
<ul style="list-style-type: none"> • at 50 Hz 	0.8 ... 1.1
<ul style="list-style-type: none"> • at 60 Hz 	0.8 ... 1.1
Design of the surge suppressor	with varistor
Apparent pick-up power of magnet coil at AC	
<ul style="list-style-type: none"> • at 50 Hz 	750 V·A
Inductive power factor with closing power of the coil	
<ul style="list-style-type: none"> • at 50 Hz 	0.8
Apparent holding power of magnet coil at AC	
<ul style="list-style-type: none"> • at 50 Hz 	7 V·A
Inductive power factor with the holding power of the coil	
<ul style="list-style-type: none"> • at 50 Hz 	0.8
Closing power of magnet coil at DC	800 W
Holding power of magnet coil at DC	3.6 W
Closing delay	
<ul style="list-style-type: none"> • at AC 	60 ... 90 ms
<ul style="list-style-type: none"> • at DC 	60 ... 90 ms
Opening delay	
<ul style="list-style-type: none"> • at AC 	80 ... 100 ms
<ul style="list-style-type: none"> • at DC 	80 ... 100 ms
Arcing time	10 ... 15 ms
Control version of the switch operating mechanism	PLC-IN or Standard A1 - A2 (adjustable)
Auxiliary circuit	
Number of NC contacts for auxiliary contacts	
<ul style="list-style-type: none"> • instantaneous contact 	2
Number of NO contacts for auxiliary contacts	
<ul style="list-style-type: none"> • instantaneous contact 	2
Operating current at AC-12 maximum	10 A
Operating current at AC-15	
<ul style="list-style-type: none"> • at 230 V rated value 	6 A
<ul style="list-style-type: none"> • at 400 V rated value 	3 A

<ul style="list-style-type: none"> • at 500 V rated value • at 690 V rated value 	<p>2 A</p> <p>1 A</p>
Operating current at DC-12	
<ul style="list-style-type: none"> • at 24 V rated value • at 48 V rated value • at 60 V rated value • at 110 V rated value • at 125 V rated value • at 220 V rated value • at 600 V rated value 	<p>10 A</p> <p>6 A</p> <p>6 A</p> <p>3 A</p> <p>2 A</p> <p>1 A</p> <p>0.15 A</p>
Operating current at DC-13	
<ul style="list-style-type: none"> • at 24 V rated value • at 48 V rated value • at 60 V rated value • at 110 V rated value • at 125 V rated value • at 220 V rated value • at 600 V rated value 	<p>10 A</p> <p>2 A</p> <p>2 A</p> <p>1 A</p> <p>0.9 A</p> <p>0.3 A</p> <p>0.1 A</p>
Contact reliability of auxiliary contacts	1 faulty switching per 100 million (17 V, 1 mA)

UL/CSA ratings

Full-load current (FLA) for three-phase AC motor	
<ul style="list-style-type: none"> • at 480 V rated value • at 600 V rated value 	<p>477 A</p> <p>472 A</p>
Yielded mechanical performance [hp]	
<ul style="list-style-type: none"> • for three-phase AC motor <ul style="list-style-type: none"> — at 200/208 V rated value — at 220/230 V rated value — at 460/480 V rated value — at 575/600 V rated value 	<p>150 hp</p> <p>200 hp</p> <p>400 hp</p> <p>500 hp</p>
Contact rating of auxiliary contacts according to UL	A600 / Q600

Short-circuit protection

Design of the fuse link	
<ul style="list-style-type: none"> • for short-circuit protection of the main circuit <ul style="list-style-type: none"> — with type of coordination 1 required — with type of assignment 2 required • for short-circuit protection of the auxiliary switch required 	<p>gG: 630 A (690 V, 100 kA)</p> <p>gG: 500 A (690 V, 100 kA), aM: 500 A (690 V, 50 kA), BS88: 500 A (415 V, 50 kA)</p> <p>gG: 10 A (500 V, 1 kA)</p>

Installation/ mounting/ dimensions

Mounting position	with vertical mounting surface +/-90° rotatable, with vertical mounting surface +/- 22.5° tiltable to the front and back
--------------------------	--

Mounting type	screw fixing
• Side-by-side mounting	Yes
Height	214 mm
Width	160 mm
Depth	225 mm
Required spacing	
• with side-by-side mounting	
— forwards	20 mm
— upwards	10 mm
— downwards	10 mm
— at the side	0 mm
• for grounded parts	
— forwards	20 mm
— upwards	10 mm
— at the side	10 mm
— downwards	10 mm
• for live parts	
— forwards	20 mm
— upwards	10 mm
— downwards	10 mm
— at the side	10 mm

Connections/Terminals	
Type of electrical connection	
• for main current circuit	Connection bar
• for auxiliary and control current circuit	screw-type terminals
Type of connectable conductor cross-sections	
• at AWG conductors for main contacts	2/0 ... 500 kcmil
Connectable conductor cross-section for main contacts	
• stranded	70 ... 240 mm ²
Connectable conductor cross-section for auxiliary contacts	
• single or multi-stranded	0.5 ... 4 mm ²
• finely stranded with core end processing	0.5 ... 2.5 mm ²
Type of connectable conductor cross-sections	
• for auxiliary contacts	
— solid	2x (0.5 ... 1.5 mm ²), 2x (0.75 ... 2.5 mm ²), max. 2x (0.75 ... 4 mm ²)
— single or multi-stranded	2x (0,5 ... 1,5 mm ²), 2x (0,75 ... 2,5 mm ²), max. 2x (0,75 ... 4 mm ²)
— finely stranded with core end processing	2x (0.5 ... 1.5 mm ²), 2x (0.75 ... 2.5 mm ²)
• at AWG conductors for auxiliary contacts	2x (20 ... 16), 2x (18 ... 14), 1x 12
AWG number as coded connectable conductor cross section	







- for auxiliary contacts

18 ... 14

Safety related data

B10 value	
<ul style="list-style-type: none"> • with high demand rate acc. to SN 31920 	1 000 000
Product function	
<ul style="list-style-type: none"> • Mirror contact acc. to IEC 60947-4-1 • positively driven operation acc. to IEC 60947-5-1 	Yes No
Protection against electrical shock	finger-safe when touched vertically from front acc. to IEC 60529

Certificates/approvals

General Product Approval		Functional Safety/Safety of Machinery	Declaration of Conformity
			
CCC	CSA	UL	EG-Konf.
		Type Examination Certificate	
Test Certificates	Marine / Shipping		other
Special Test Certificate	Type Test Certificates/Test Report		Confirmation
			
	ABS	RMRS	DNV-GL DNVGL.COM/AF
other			
Miscellaneous			

Further information

Information- and Downloadcenter (Catalogs, Brochures,...)

<http://www.siemens.com/industrial-controls/catalogs>

Industry Mall (Online ordering system)

<https://mall.industry.siemens.com/mall/en/en/Catalog/product?mlfb=3RT1076-6NF36>

Cax online generator

<http://support.automation.siemens.com/WW/CAXorder/default.aspx?lang=en&mlfb=3RT1076-6NF36>

Service&Support (Manuals, Certificates, Characteristics, FAQs,...)

<https://support.industry.siemens.com/cs/ww/en/ps/3RT1076-6NF36>

Image database (product images, 2D dimension drawings, 3D models, device circuit diagrams, EPLAN macros, ...)

http://www.automation.siemens.com/bilddb/cax_de.aspx?mlfb=3RT1076-6NF36&lang=en

Characteristic: Tripping characteristics, I^t, Let-through current

<https://support.industry.siemens.com/cs/ww/en/ps/3RT1076-6NF36/char>

Further characteristics (e.g. electrical endurance, switching frequency)

<http://www.automation.siemens.com/bilddb/index.aspx?view=Search&mlfb=3RT1076-6NF36&objecttype=14&gridview=view1>

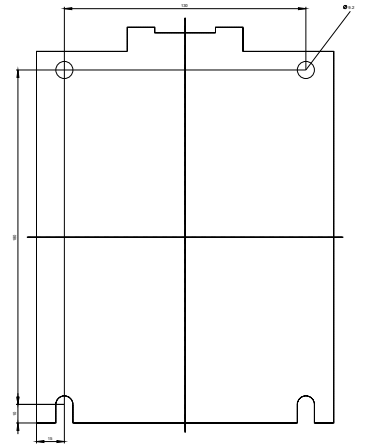
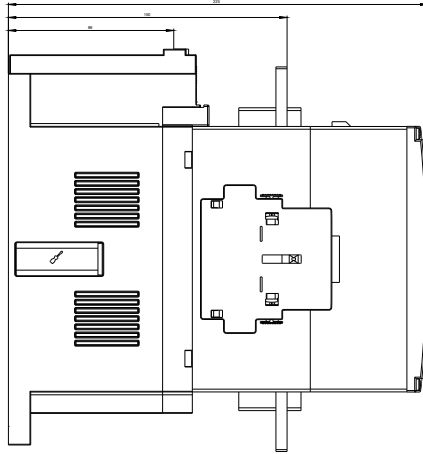
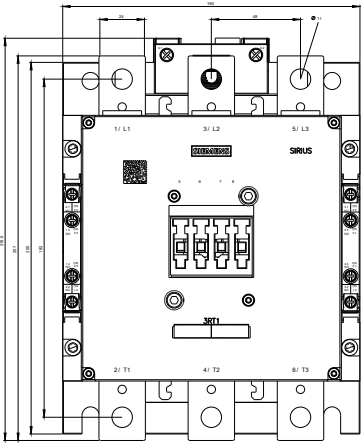

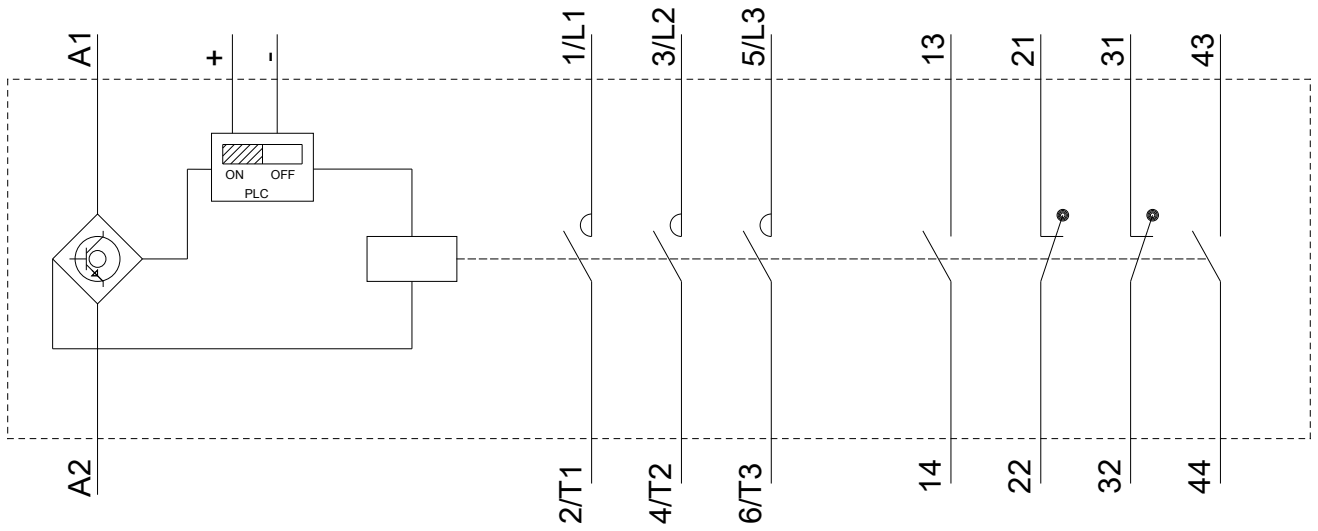

last modified:

12/22/2018